

NO.	DATE	REVISION & DESCRIPTION	REVIEWED	CHECKED
△			SIGNATURE	

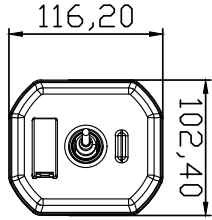

FRONT VIEW

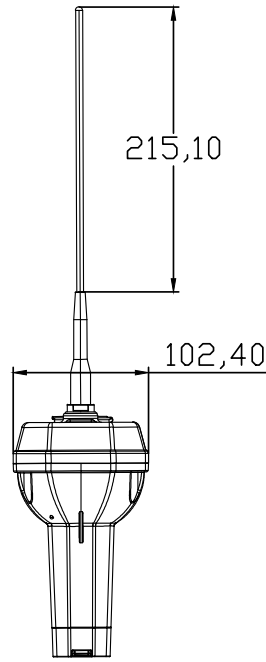

SIDE VIEW

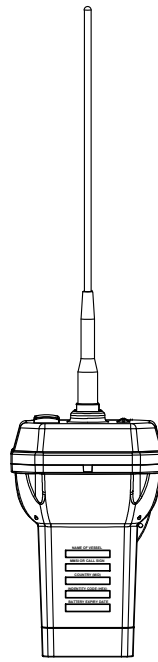

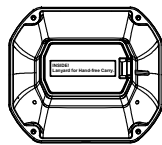
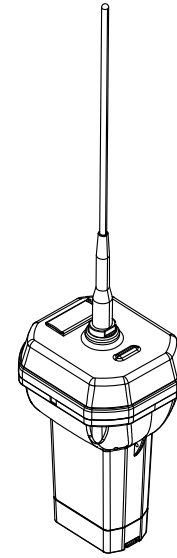

REAR VIEW

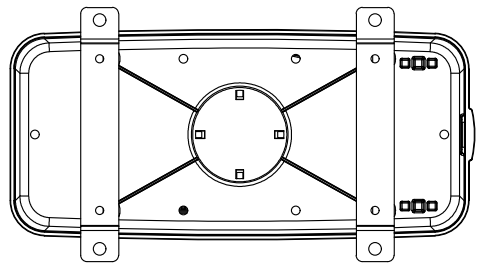
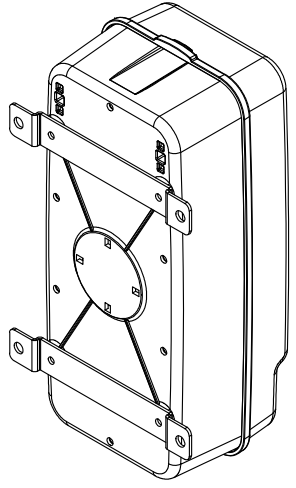
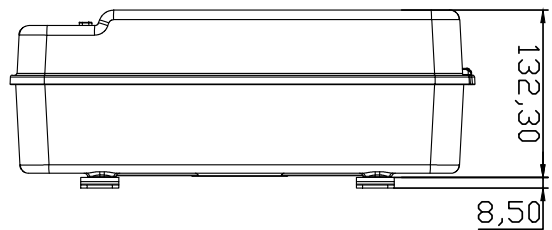
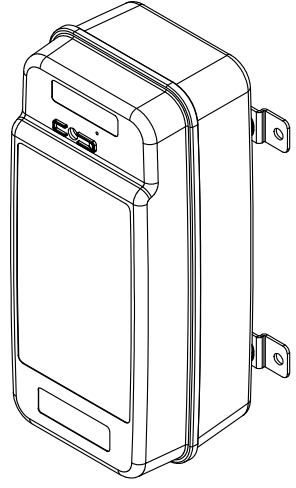
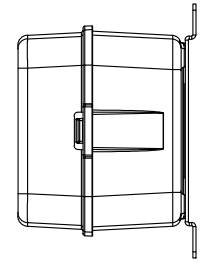
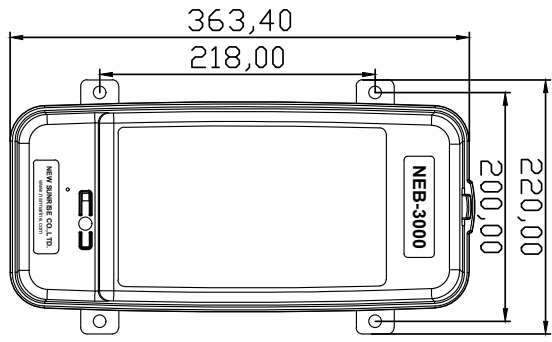
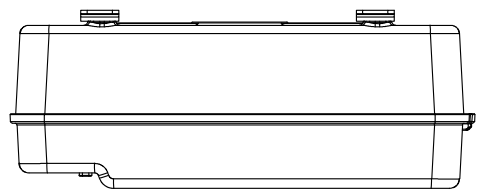
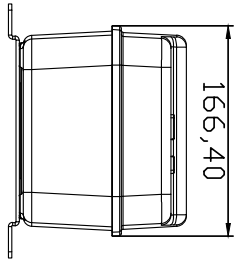

APPLICATION		NEB-3000 SIZE DRAWING			
DATE		ITEM		SCALE	SIZE A4
APPROVAL		SCALE	UNIT	PRO-PORTION	UNITS
CHECKED					
DRAWING					
DWG. NO.	NEB3000-ID-001				

NO.	DATE	REVISION & DESCRIPTION	REVIEWED	CHECKED
△			SIGNATURE	



APPLICATION		NEB-3000 CONTAINER SIZE DRAWING			
DATE		ITEM		SCALE	SIZE A4
APPROVAL		SCALE	1:1	UNIT	mm
CHECKED		PROJ.	DESIGN	DATE	00/00/00
DRAWING		 NEW SUNRISE CO., LTD.			
DWG. NO.	NEB3000-ID-002				

NO.	DATE	REVISION & DESCRIPTION	REVIEWED SIGNATURE	CHECKED SIGNATURE
△				

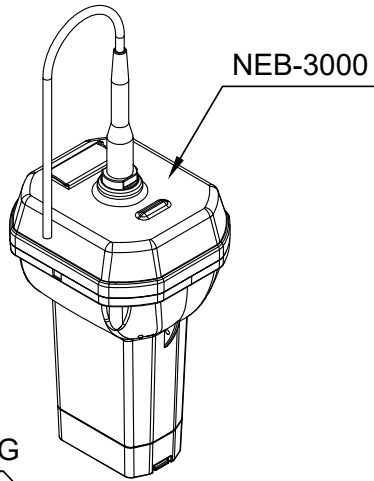

RUBBER RING

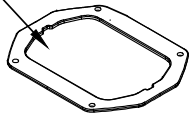

BRACKET ①

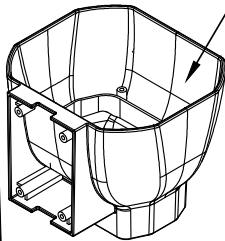

BRACKET ②

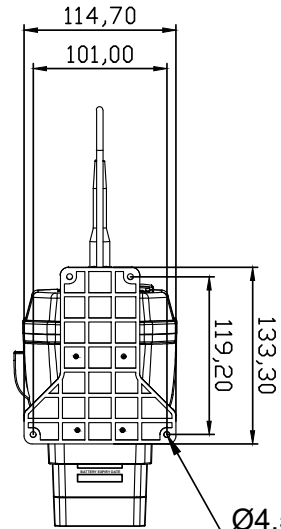
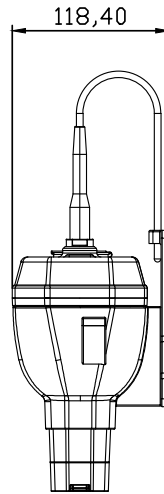
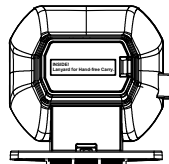
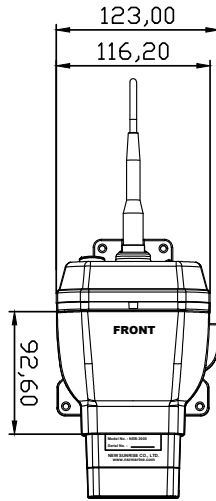
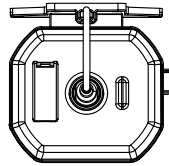
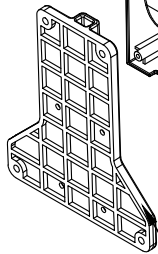

Ø4.5-4
Mounting Hole

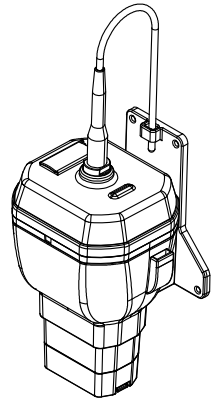

APPLICATION		NEB-3000 MOUNTING DRAWING			
DATE		ITEM		SCALE	SIZE A4
APPROVAL		SCALE	N/S	UNIT	mm
CHECKED		PROJ.	SECTION	DATE	11/25/15
DRAWING		NEW SUNRISE CO., LTD.			
DWG. NO.	NEB3000-ID-003				